

Tsunami Countertops



Concrete Sink Molds



and

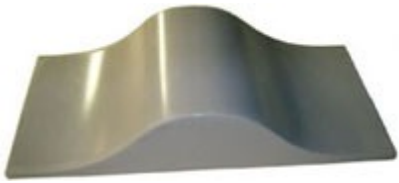

Reusable Edge Forms

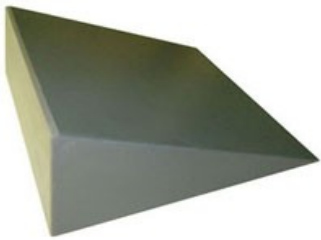

July 2007 Catalog



Tsunami Countertops
570 East 100 South, Pleasant Grove, UT. 84062
p. (801)310-0936 f. (801)785-8080
web. www.tsunamicountertops.com
e. sales@tsunamicountertops.com



Sink Part: TC500T	Style: Wave Sink	Drain: Slot Drain
<p><u>Measurements:</u> Length: 29" Width: 14¼" Depth: 6¾" Middle, ½" Ends</p> <p>Drain Length: 12½" ¼" Thick plexiglass drain insert included.</p>		

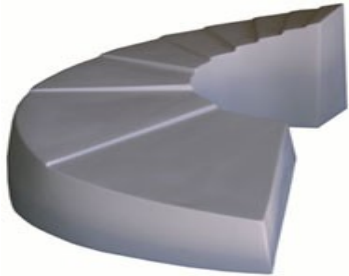

Sink Part: TC510R	Style: Ramp Sink	Drain: Slot Drain
<p><u>Measurements:</u> Length: 15 ¾"(Front to Back) Width: 16.125" Depth: 6" At Drain</p> <p>Drain Length: 15¾" ¼" Thick plexiglass drain insert included.</p>		



Sink Part: TC520B	Style: Bowl Sink	Drain: Standard Bathroom Size
<p><u>Measurements:</u> Diameter: 15¼" Depth: 5¼"</p> <p>One disposable foam drain hole knockout included.</p>		

Sink Part: TC530F	Style: Farm Sink	Drain: Standard Kitchen Size
<p><u>Measurements:</u> Length: 21" Width: 15¾" Depth: 8½"</p> <p>One disposable foam drain hole knockout included.</p>		



Sink Part: TC540S	Style: Staircase Sink	Drain: Slot Drain
<p><u>Measurements:</u> Length: 19" Width: 12" Depth: 7½"</p> <p>One disposable foam drain hole knockout included.</p> <p>Soon to be discontinued and replaced with TC541S.</p>		



Sink Part: TC550SB	Style: Layered Basin Sink	Drain: Standard Bathroom Size
<p><u>Measurements:</u> Length: 22" Width: 16" (Left) 14" (Right) Depth: 7"</p> <p>One disposable foam drain hole knockout included.</p>		

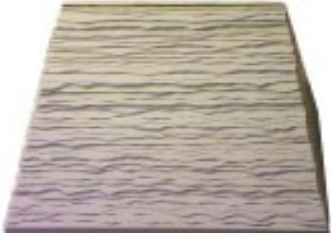

Sink Part: TC560TR	Style: Trough Sink	Drain: Standard Bathroom Size
<p><u>Measurements:</u> Length: 48" Width: 14" Depth: 6½"</p> <p>One disposable foam drain hole knockout included.</p>		



Sink Part: TC570U	Style: Utility Sink	Drain: Standard Kitchen Size
<p><u>Measurements:</u> Length: 15 3/8" Width: 14 ¼" Depth: 9"</p> <p>One disposable foam drain hole knockout included.</p> <p>Two side-by-side work well for kitchen sinks.</p>		

Sink Part: TC580MR	Style: Layered Ramp Sink	Drain: Slot Drain
<p><u>Measurements:</u> Length: " Width: " Depth: "</p> <p>One disposable foam drain hole knockout included.</p>		

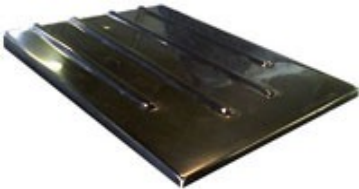
Sink Part: TC590TE	Style: Tear Sink	Drain: Standard Kitchen Size
<p><u>Measurements:</u> Length: " Width: " Depth: "</p> <p>One disposable foam drain hole knockout included.</p>		

Sink Part: TC600Y	Style: Yin-Yang Sink	Drain: Standard Kitchen Size
<p><u>Measurements:</u> Length: " Width: " Depth: "</p> <p>Two disposable foam drain hole knockouts included.</p>		

Sink Part: TC610DB	Style: Drain Board Insert	Drainage: Sloped and Grooves
<p><u>Measurements:</u> Length: 16" Width: 12" Depth: 3/8" - 3/4"</p> <p>Sloped towards sink, and has 4 drain grooves.</p>		

Sink Part: TC800R	Style: Edge Form, Reusable	Pattern: Chipped Rock
<p>Measurements: Length: 8 Feet Height: 2"</p> <p>Cuts with sharp razor knife. Join cut sections with silicone.</p>		



Sink Part: TC810R	Style: Edge Form, Reusable	Pattern: Chipped Rock
<p>Measurements: Length: 8 Feet Height: 4"</p> <p>Cuts with sharp razor knife. Join cut sections with silicone.</p>	<p>Product Not Yet Available</p>	

Sink Part: TC820S	Style: Edge Form, Reusable	Pattern: Sandstone
<p>Measurements: Length: 8 Feet Height: 2"</p> <p>Cuts with sharp razor knife. Join cut sections with silicone.</p>	<p>Product Not Yet Available</p>	

Sink Part: TC830S	Style: Edge Form, Reusable	Pattern: Sandstone
<p>Measurements: Length: 8 Feet Height: 4"</p> <p>Cuts with sharp razor knife. Join cut sections with silicone.</p>	<p>Product Not Yet Available</p>	

Sink Part: TC8400G	Style: Edge Form, Reusable	Pattern: OG
<p>Measurements: Length: 8 Feet Height: 2"</p> <p>Cuts with sharp razor knife. Join cut sections with silicone.</p>	Product Not Yet Available	

Sink Part: TC850B	Style: Edge Form, Reusable	Pattern: Capstone
<p>Measurements: Length: 8 Feet Height: 2"</p> <p>Cuts with sharp razor knife. Join cut sections with silicone.</p>	Product Not Yet Available	

Sink Part: TC900D-	Style: Slot Drain Kit	Material: Stainless Steel
<p><u>Measurements:</u> TC900D-RAMP Length: 17" (18½" Outer) Width: 3" (4½" Outer) Depth: 1" TC900D-WAVE Length: 13½" (15" Outer) Width: 3" (4½" Outer) Depth: 1"</p> <p>Kit includes drain pan, drain pipe, concrete bit, 4 concrete screws.</p>		

Sink Part: TC910D-	Style: Slot Drain Kit	Material: Polyvinyl (plastic)
<p><u>Measurements:</u> TC910D-RAMP Length: 17½" Width: 4" Depth: 2" TC910D-WAVE Length: 14" Width: 4" Depth: 2"</p> <p>Kit includes drain pan, drain pipe, concrete bit, 4 concrete screws.</p>	